

Ścianka tekstylna ŁUKOWA C

Montaż ścianki 2,4 i 3 m

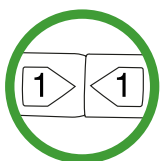

1 Połącz elementy z elastycznym sznurkiem

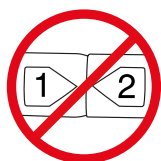
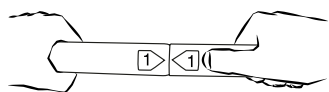
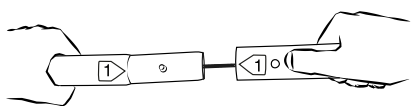
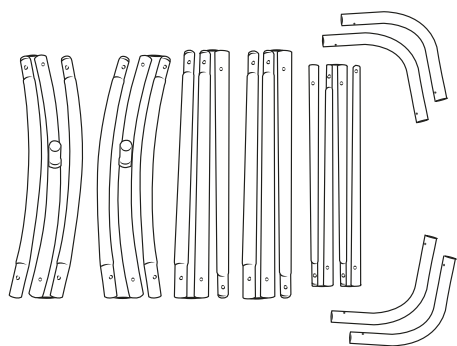
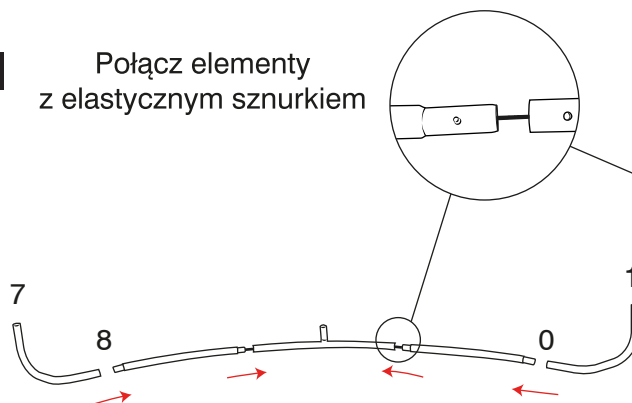

2

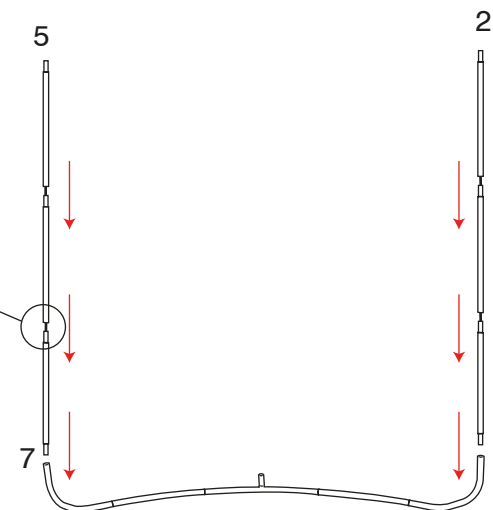

3

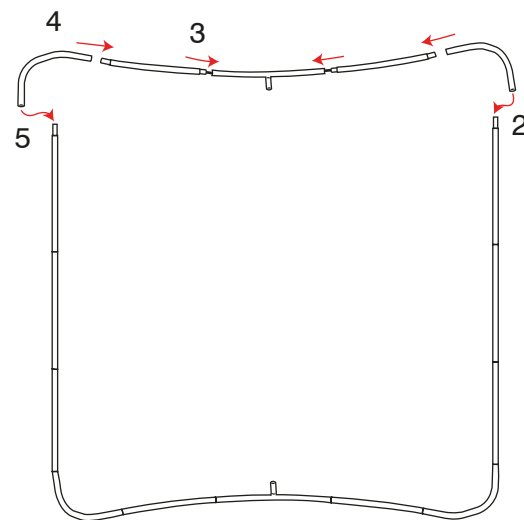

4

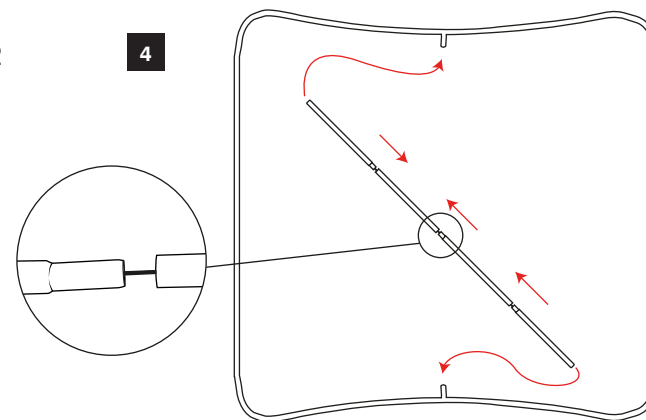

Ścianka tekstylna ŁUKOWA C

5

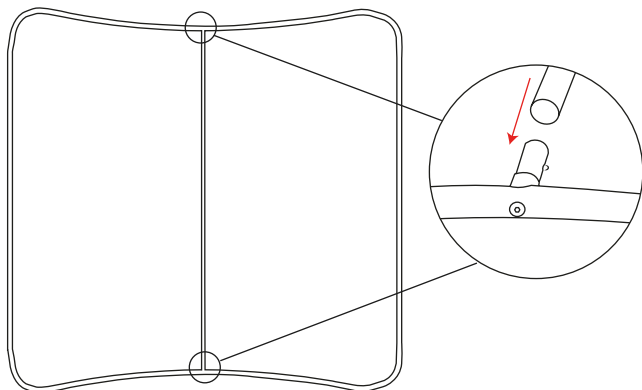

6

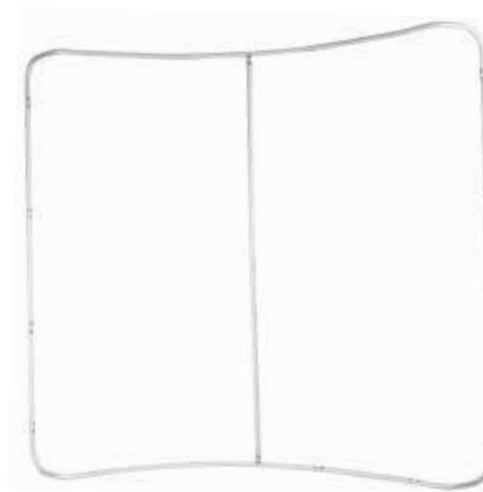

Montaż grafiki

1 Załóż grafikę od góry. Jeżeli to konieczne, załóż rękawiczki, żeby nie wybrudzić grafiki.

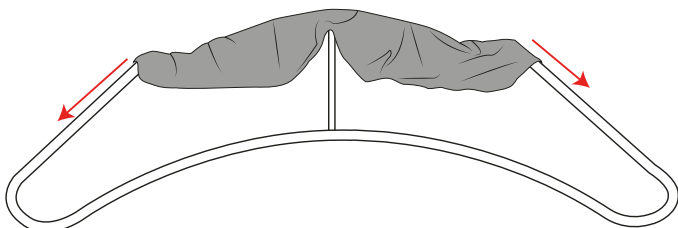

2

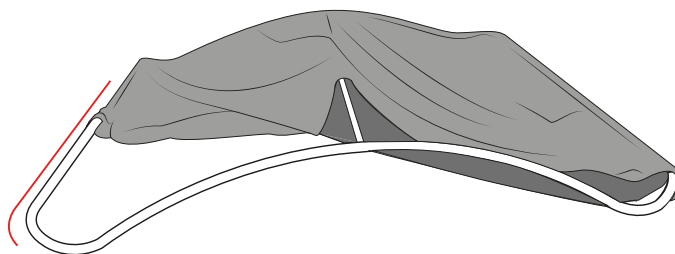

3 Zapnij zamek.

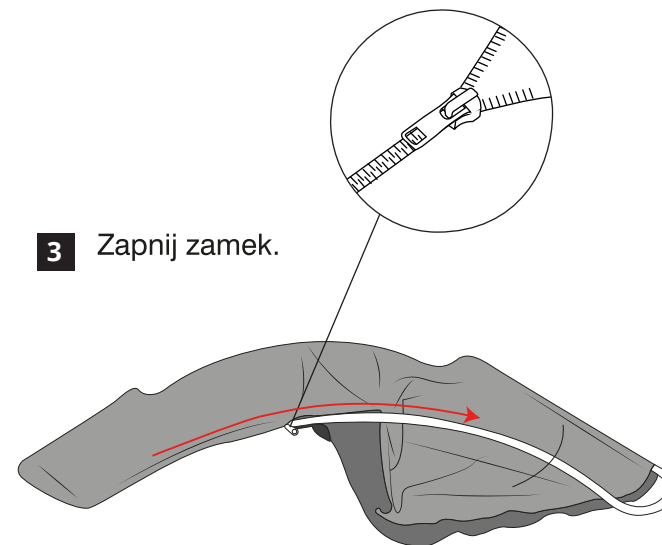

Ścianka tekstylna ŁUKOWA C

Montaż ścianki 6 m

1

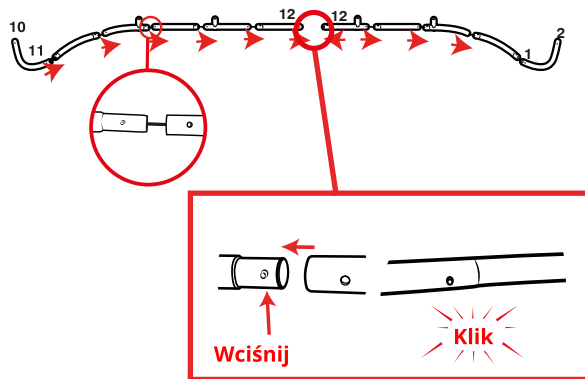

2

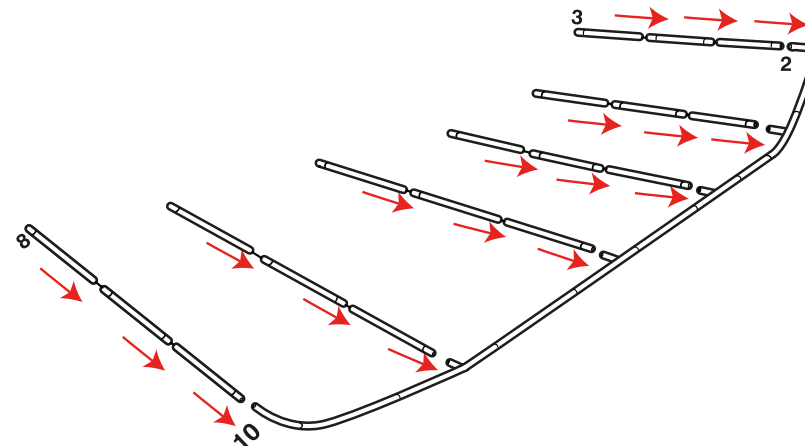

3

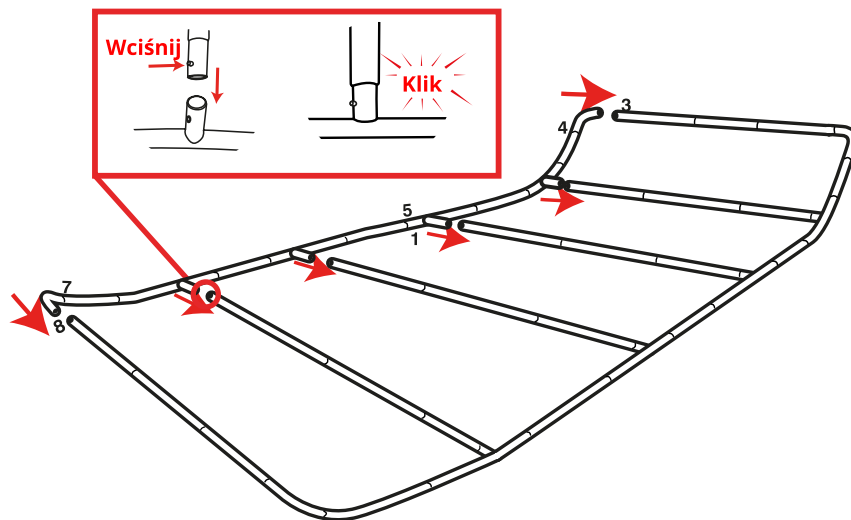

Ścianka tekstylna ŁUKOWA C

Montaż grafiki

1

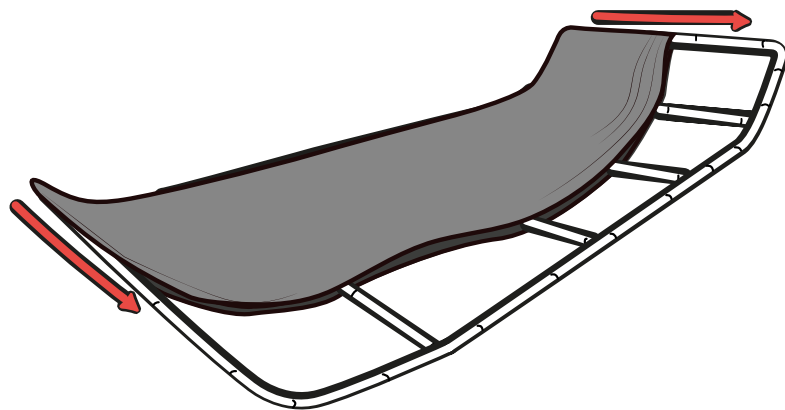

2

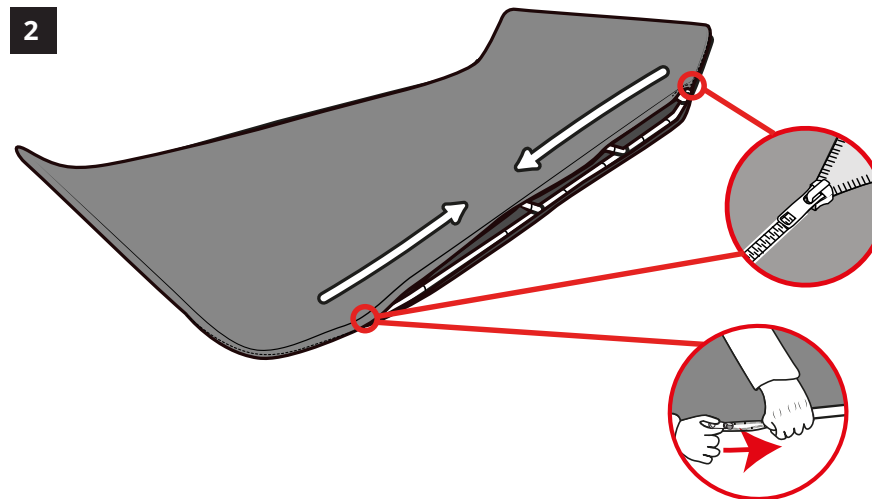

3

